

VF-WF-SERIES

PLATE AXIAL FAN



DESCRIPTION

- ✓ Fan diameter is from 200mm to 630mm
- ✓ External rotor motor, metal fan body and metal fan blade with metal frame.
- ✓ Operation temperature: -30°C~60°C
- ✓ High airflow and high air pressure

DIMENSIONS (MM)

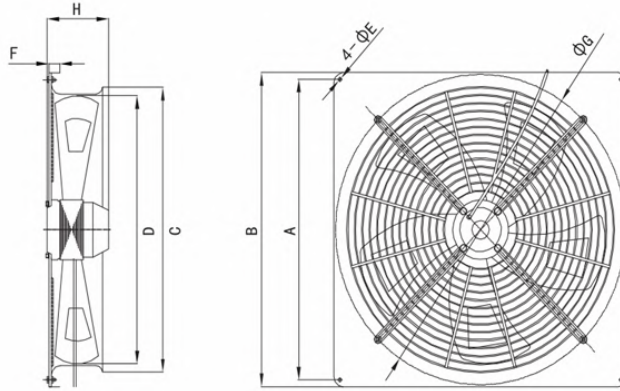

MODEL	A	B	C	D	E	F	G	H
VF-WF-200	260	310	230	200	7	15	210	50
VF-WF-250	320	370	280	250	7	15	260	50
VF-WF-300	380	430	335	300	7	15	315	80
VF-WF-350	435	485	380	350	10	15	360	80
VF-WF-400	490	540	430	400	10	15	410	100
VF-WF-450	520	575	480	450	10	15	460	100
VF-WF-500	625	665	530	500	10	15	510	100
VF-WF-550	665	725	585	550	10	15	565	100
VF-WF-600	725	770	635	600	10	20	615	120
VF-WF-630	750	805	665	630	10	20	645	120

PERFORMANCE

MODEL	SPEED	VOLTAGE	CURRENT (AMPS)	POWER (kW)	SPEED (RPM)	AIRFLOW (m3/h)	AIR PRESSURE (Pa)	NOISE (dB)
VF-WF-200	SET SPEED	220/50	0,2	0,04	1450	540	80	45
VF-WF-250	SET SPEED	220/50	0,25	0,056	1400	770	70	52
VF-WF-300	SET SPEED	220/50	0,45	0,06	910	1260	108	50
VF-WF-350	SET SPEED	220/50	0,5	0,09	950	1650	75	58
VF-WF-400	SET SPEED	220/50	0,57	0,11	920	2510	85	58
VF-WF-450	SET SPEED	220/50	0,7	0,15	920	3550	85	60
VF-WF-500	SET SPEED	220/50	0,65	0,14	900	4900	100	68
VF-WF-550	SET SPEED	220/50	1,6	0,28	900	6430	110	70
VF-WF-600	SET SPEED	220/50	2,5	0,39	900	8100	120	72
VF-WF-630	SET SPEED	220/50	2,55	0,47	900	8850	120	75

PERFORMANCE CURVES



VF-WF-200

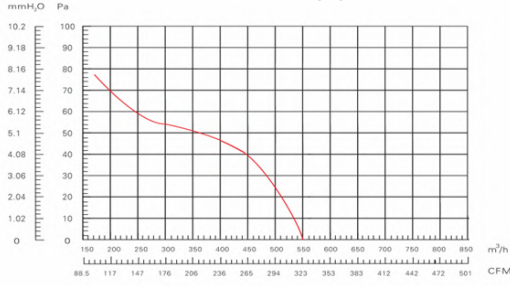

VF-WF-250

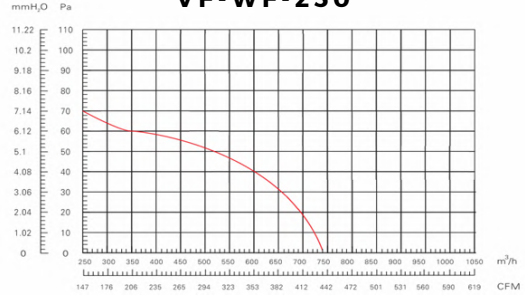

VF-WF-300

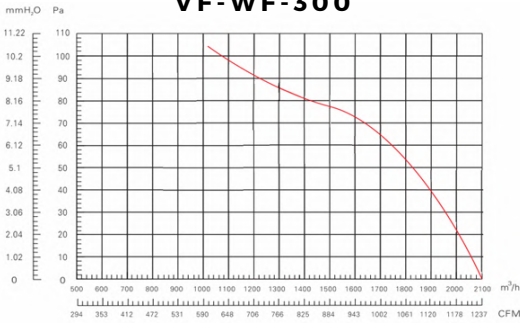

VF-WF-350

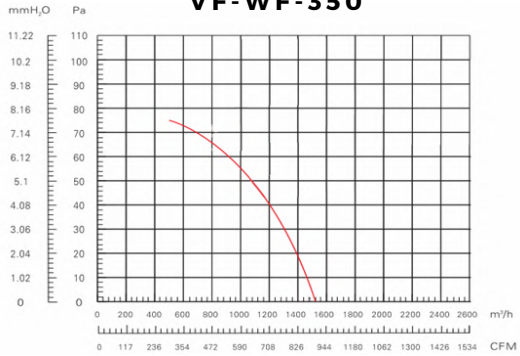

VF-WF-400

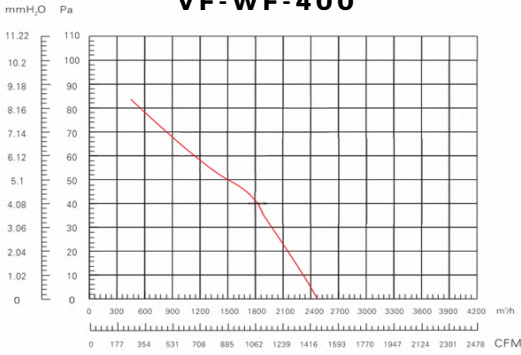

VF-WF-450

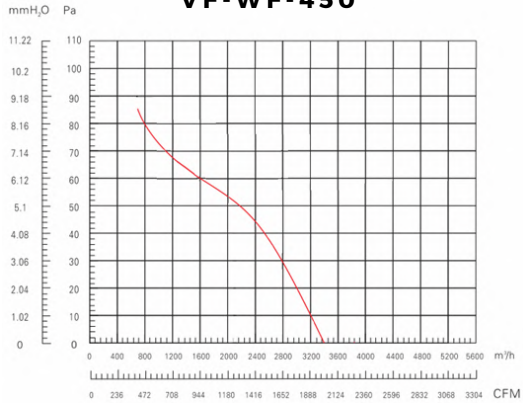

VF-WF-500

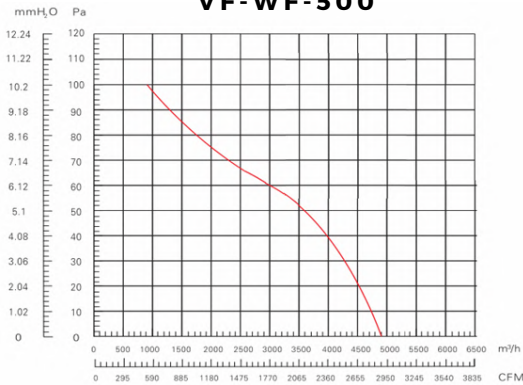

VF-WF-550

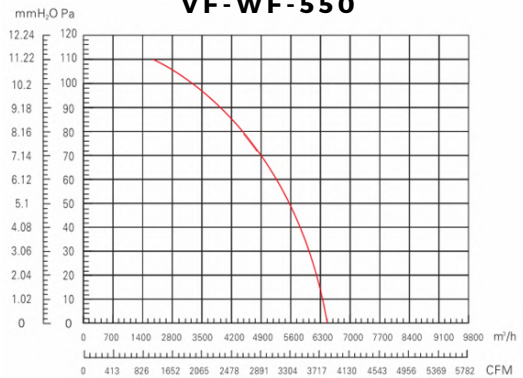

VF-WF-600

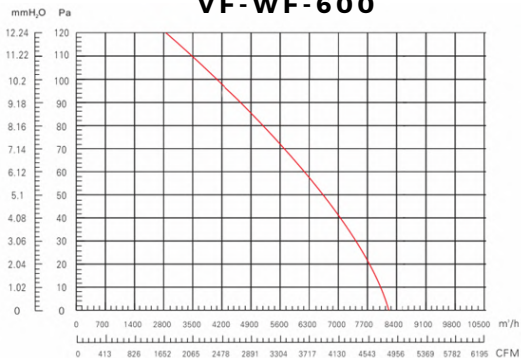

VF-WF-650

